

File: 23/20
Date: 15 August 2023

SMK QLD Pty Ltd for William Boyd
PO Box 422
GOONDIWINDI QLD 4390

Attention: Tom Jobling

Dear Tom

**Decision Notice –approval (with conditions)
Material Change of Use
Lot 62 on SP200619, Glasser Street, Goondiwindi**

We wish to advise that on 8 August 2023 a decision was made to approve the material change of use development application for “*Industry activities*” – “*Low Impact Industry*”, “*Warehouse*” and “*Transport Depot*” at Lot 62 on SP200619, Glasser Street, Goondiwindi. In accordance with the *Planning Act 2016*, please find attached Council’s Decision Notice for the application.

Please read the conditions carefully as these include actions which must be undertaken **prior to the commencement of the use** as well as requirements for the ongoing operation of the use.

All conditions are required to be either complied with or bonded prior to the commencement of the use. Please note **Condition 33**, which requires a letter to be submitted to Council prior to commencement of the use, outlining and demonstrating compliance with each condition.

The applicant is required to **notify Council in writing of the date of the commencement** of the use, within fourteen (14) business days of commencement.

If you require any further information, please contact Council’s Manager of Planning Services, Mrs Ronnie McMahon, on (07) 4671 7400 or rmcmahon@grc.qld.gov.au, who will be pleased to assist.

Yours faithfully



Ronnie McMahon
Manager of Planning Services
Goondiwindi Regional Council

Decision Notice approval

Planning Act 2016 section 63

Council File Reference: 23/20
Council Contact: Mrs Ronnie McMahon
Council Contact Phone: (07) 4671 7400

15 August 2023

Applicant Details: SMK QLD Pty Ltd for William Boyd
PO Box 422
GOONDIWINDI QLD 4390

Attention: Tom Jobling

The development application described below was properly made to Goondiwindi Regional Council on 19 May 2023.

Applicant details

Applicant name: SMK QLD Pty Ltd for William Boyd
Applicant contact details: Attn: Mr Tom Jobling
PO Box 422, Goondiwindi, QLD 4390
tom@smkqld.com.au
(07) 4671 2445

Application details

Application number: 23/20
Approval sought: Development Permit – Material Change of Use
Details of proposed development: “Industry activities” – “Low Impact Industry”, “Warehouse” and “Transport Depot”

Location details

Street address: Glasser Street, Goondiwindi
Real property description: Lot 62 on SP200619

Decision

Date of decision: 8 August 2023
Decision details: Approved in full with conditions. These conditions are set out in Attachment 1 and are clearly identified to indicate whether the assessment manager or a concurrence agency imposed them.

Details of the approval

The application is not taken to be approved (a deemed approval) under section 64(5) of the *Planning Act 2016*.

The following approvals are given:

	Planning Regulation 2017 reference	Development Permit	Preliminary Approval
Development assessable under the planning scheme, superseded planning scheme, a temporary local planning instrument, a master plan or a preliminary approval which includes a variation approval - building work assessable under the planning scheme - plumbing or drainage work - material change of use - reconfiguring a lot - operational work	N/A	<input type="checkbox"/> <input type="checkbox"/> <input checked="" type="checkbox"/> <input type="checkbox"/> <input type="checkbox"/>	<input type="checkbox"/> <input type="checkbox"/> <input type="checkbox"/> <input type="checkbox"/>

Conditions

This approval is subject to the conditions in Attachment 1.

Further development permits

Please be advised that the following development permits are required to be obtained before the development can be carried out:

1. Development Permit – Building Work
2. Compliance Permit – Plumbing Work

Properly made submissions

Not applicable—No part of the application required public notification.

Referral agencies for the application

The referral agencies for this application are:

For an application involving	Name of referral agency	Address
As per Schedule 10, Part 9, Division 4, Subdivision 2, Table 4, Item 1 (10.9.4.2.4.1) of the PR: <i>Development application for a material change of use, other than an excluded material change of use, that is assessable development under a local categorising instrument, if all or part of the premises—</i> (a) are within 25m of a State transport corridor; or	Department of State Development, Infrastructure, Local Government and Planning – Concurrence Agency	Department of State Development, Infrastructure, Local Government and Planning, Post: PO Box 825, Visit: 128 Margaret Street, TOOWOOMBA QLD 4350

For an application involving	Name of referral agency	Address
<p>(b) are a future State transport corridor; or</p> <p>(c) are—</p> <p>(i) adjacent to a road that intersects with a State-controlled road; and</p> <p>(ii) within 100m of the intersection</p>		<p>ToowoombaSARA@dsdilgp.qld.gov.au</p> <p>Ph: (07) 4616 7307</p>

Approved plans and specifications

Copies of the following plans are enclosed.

Drawing Number	Title	Date
23041-1	Site Plan for MCU Application Lot 62 SP200619	31/3/2023
Job No 1192486326 Sheet 2 of 8	Elevations	06-03-2023
Job No 1192486326 Sheet 4 of 8	Floor Plan	06-03-2023
TE 138-03.1	Framing Details	Jan 2007

Currency period for the approval

This development approval will lapse at the end of the period set out in section 85 of *Planning Act 2016*

Rights of appeal

The rights of an applicant to appeal to a tribunal or the Planning and Environment Court against a decision about a development application are set out in chapter 6, part 1 of the *Planning Act 2016*. For certain applications, there may also be a right to make an application for a declaration by a tribunal (see chapter 6, part 2 of the *Planning Act 2016*).

Appeal by an applicant

An applicant for a development application may appeal to the Planning and Environment Court against the following:

- the refusal of all or part of the development application
- a provision of the development approval
- the decision to give a preliminary approval when a development permit was applied for
- a deemed refusal of the development application.

An applicant may also have a right to appeal to the Development tribunal. For more information, see schedule 1 of the *Planning Act 2016*.

The timeframes for starting an appeal in the Planning and Environment Court are set out in section 229 of the *Planning Act 2016*.

Attachment 5 is an extract from the *Planning Act 2016* that sets out the applicant's appeal rights and the appeal rights of a submitter.

To stay informed about any appeal proceedings which may relate to this decision visit:
<https://planning.dsdmip.qld.gov.au/planning/our-planning-system/dispute-resolution/pe-court-database>.

Attachment 4 is a Notice about decision - Statement of reasons, in accordance with section 63 (5) of the Planning Act 2016.

If you wish to discuss this matter further, please contact Council's Manager of Planning Services, Mrs Ronnie McMahon, on 07 4671 7400.

Yours Sincerely



Ronnie McMahon
Manager of Planning Services
Goondiwindi Regional Council

Cc Department of State Development, Infrastructure,
Local Government and Planning,
PO Box 825,
TOOWOOMBA QLD 4350

enc Attachment 1— Assessment manager and concurrence agency conditions

- State Assessment and Referral Agency Concurrence Agency Response dated 3 July 2023

Attachment 2—Approved Plans
Attachment 3—Infrastructure Charges Notice
Attachment 4—Notice about decision – Statement of reasons
Attachment 5—*Planning Act 2016* Extracts



ATTACHMENTS

Attachment 1 – Assessment Manager’s Conditions

Attachment 2 – Approved Plans

Attachment 3 – Infrastructure Charges Notice

Attachment 4 – Notice about decision - Statement of reasons

Attachment 5 – *Planning Act 2016* Extracts

Planning Act 2016 appeal provisions

Planning Act 2016 lapse dates



Attachment 1 – Assessment Manager's Conditions



Assessment Manager's Conditions

Description:	<ul style="list-style-type: none"> • <i>"Industry activities" – "Low Impact Industry", "Warehouse" and "Transport Depot"</i>
Development:	Material Change of Use – Development Permit
Applicant:	SMK QLD Pty Ltd for William Boyd
Address:	Glasser Street, Goondiwindi
Real Property Description:	Lot 62 on SP200619
Council File Reference:	23/20

GENERAL CONDITIONS																
1.	<p>Approval is granted for the purpose of a Material Change of Use for:</p> <ul style="list-style-type: none"> • <i>"Industry activities" – "Low Impact Industry", "Warehouse" and "Transport Depot"</i> <p>as defined in the <i>Goondiwindi Region Planning Scheme 2018 (Version 2)</i>.</p>															
2.	All conditions must be complied with or bonded prior to the commencement of the use, unless specified in an individual condition.															
3.	<p>Except where changed by conditions of this approval, the development shall be in accordance with supporting information supplied by the applicant with the development application including the following plans:</p> <table border="1"> <thead> <tr> <th>Drawing Number</th> <th>Title</th> <th>Date</th> </tr> </thead> <tbody> <tr> <td>23041-1</td> <td>Site Plan for MCU Application Lot 62 SP200619</td> <td>31/3/2023</td> </tr> <tr> <td>Job No 1192486326 Sheet 2 of 8</td> <td>Elevations</td> <td>06-03-2023</td> </tr> <tr> <td>Job No 1192486326 Sheet 4 of 8</td> <td>Floor Plan</td> <td>06-03-2023</td> </tr> <tr> <td>TE 138-03.1</td> <td>Framing Details</td> <td>Jan 2007</td> </tr> </tbody> </table> <p>Please note these plans are not approved Building Plans.</p>	Drawing Number	Title	Date	23041-1	Site Plan for MCU Application Lot 62 SP200619	31/3/2023	Job No 1192486326 Sheet 2 of 8	Elevations	06-03-2023	Job No 1192486326 Sheet 4 of 8	Floor Plan	06-03-2023	TE 138-03.1	Framing Details	Jan 2007
Drawing Number	Title	Date														
23041-1	Site Plan for MCU Application Lot 62 SP200619	31/3/2023														
Job No 1192486326 Sheet 2 of 8	Elevations	06-03-2023														
Job No 1192486326 Sheet 4 of 8	Floor Plan	06-03-2023														
TE 138-03.1	Framing Details	Jan 2007														

4.	<p>Complete and maintain the approved development as follows:</p> <ul style="list-style-type: none"> (i) Generally in accordance with development approval documents; and (ii) Strictly in accordance with those parts of the approved development which have been specified in detail by Council unless Council agrees in writing that those parts will be adequately complied with by amended specifications. <p>All development shall comply with any relevant provisions in the <i>Goondiwindi Region Planning Scheme 2018 (Version 2)</i>, Council's standard designs for applicable work and any relevant Australian Standard that applies to that type of work.</p> <p>The development approval documents are the material contained in the development application, approved plans and supporting documentation including any written and electronic correspondence between applicant, Council or any relevant Agencies during all stages of the development application assessment processes.</p>
5.	<p>The developer shall contact Council's Engineering Department to ensure the correct specifications are obtained for all civil works prior to commencement of any works onsite.</p>
6.	<p>It is the developer's responsibility to obtain all other statutory approvals required prior to the commencement of the use.</p>
OPERATION OF THE USE	
7.	<p>The approval is over two (2) stages as follows:</p> <ul style="list-style-type: none"> • Stage 1: Existing Shed, Shed 1, infrastructure and hardstand areas • Stage 2: Shed 2 <p>Conditions within this approval apply to all stages unless otherwise specified.</p>
8.	<p>The proposed industry activities shall be operated generally between the hours of 6:30am and 5:00pm, Monday to Friday.</p>
ESSENTIAL SERVICES	
9.	<p>Connection to Council's reticulated water supply system shall be maintained to the subject site, in accordance with Schedule 6.2 Planning Scheme Policy 1 – Land Development Standards in the <i>Goondiwindi Region Planning Scheme 2018 (Version 2)</i>, at no cost to Council.</p> <p>The site shall be provided with all necessary water infrastructure, including backflow prevention devices, to enable the development to be serviced to relevant engineering standards and to the satisfaction of Council.</p>

10.	<p>Prior to the commencement of the use, the development shall be connected to an approved designed onsite effluent disposal sewerage system, in accordance with the Queensland Plumbing and Wastewater Code, to the satisfaction of and at no cost to Council.</p> <p>All sewer infrastructure (including effluent disposal areas) shall be fully located within site boundaries, to the satisfaction of and at no cost to Council.</p>
PUBLIC UTILITIES	
11.	<p>The development shall be connected to an adequate electricity and telecommunications supply system, at no cost to Council.</p>
ROADS AND VEHICLES	
12.	<p>The Glasser Street access, shall be upgraded from the edge of the existing bitumen to the property boundary to an industrial standard in accordance with Schedule 6.2.1 – Standard Drawing in Schedule 6.2 – Planning Scheme Policy 1 – Land Development Standards of the <i>Goondiwindi Region Planning Scheme 2018 (Version 2)</i>, to the satisfaction of and at no cost to Council.</p> <p>Crossovers shall be either constructed or bonded prior to the commencement of the use.</p> <p>The developer shall contact Council's Engineering Department to ensure the correct specifications are obtained for all civil works prior to commencement of any works onsite. A qualified Council Officer may inspect construction works at the request of the development to ensure compliance with this condition.</p>
13.	<p>Vehicle manoeuvring areas shall be provided on-site so that all vehicles, including all heavy vehicles, can enter and leave the site in a forward direction.</p>
14.	<p>Twenty-two (22) car parking spaces for the proposed building shall be supplied on site. This area shall be constructed to a dust suppressant all-weather standard in accordance with Schedule 6.2 – Planning Scheme Policy 1 – Land Development Standards of the <i>Goondiwindi Region Planning Scheme 2018 (Version 2)</i>, to the satisfaction of and at no cost to Council.</p> <p>The developer shall contact Council's Engineering Department to ensure the correct specifications are obtained for all civil works prior to commencement of any works onsite. A qualified Council Officer may inspect construction works at the request of the developer to ensure compliance with this condition.</p>

	LANDSCAPING
15.	<p>All existing landscaping areas, as shown on the Approved Plan, shall be maintained in accordance with Schedule 6.3 – Planning Scheme Policy 3 – Landscaping Standards of the <i>Goondiwindi Region Planning Scheme 2018 (Version 2)</i>.</p> <p>No equipment, goods, materials or vehicles are to be stored or placed within the landscaping areas.</p>
	STORMWATER
16.	<p>Prior to the commencement of the use, the site shall be adequately drained and all stormwater shall be disposed of to a legal point of discharge in accordance with Schedule 6.2 – Planning Scheme Policy 1 – Land Development Standards of the <i>Goondiwindi Region Planning Scheme 2018 (Version 2)</i>, to the satisfaction of and at no cost to Council.</p> <p>Any increase in volume, concentration or velocity of stormwater from the site shall be channelled to lawful points of discharge or to other storage or dispersal arrangements which all must be agreed to in writing by Council.</p> <p>There shall be no change in direction or increase in the volume, concentration or velocity in any overland flow from the site to any adjoining properties unless agreed in writing by Council and the owners of any adjoining properties affected by these changes.</p> <p>The stormwater disposal system shall be designed to include appropriate pollution control devices or methods to ensure no contamination or silting or waterways.</p>
17.	<p>Stormwater shall not be allowed to pond on the site during the development process and after development has been completed unless the type and size of ponding has been agreed in writing by Council.</p> <p>No ponding, concentration or redirection of stormwater shall occur on adjoining properties unless specifically agreed to in writing by Council and the owners of any adjoining properties affected by these changes.</p>
	EARTHWORKS AND EROSION CONTROL
18.	<p>Any filling or excavation shall be undertaken in accordance with Schedule 6.2 – Planning Scheme Policy 1 – Land Development Standards of the <i>Goondiwindi Region planning Scheme 2018 (Version 2)</i> or to other relevant engineering standards to the satisfaction of and at no cost to Council.</p> <p>Excavation or filling within 1.5 metres of any site boundary is battered or retained by a wall that does not exceed 1 metre in height.</p>

19.	<p>All works associated with the development must be carried out in a manner that minimises erosion and controls sediment. Best practice erosion and sediment control measures shall be in place at the location of all works prior to work commencing and remain until work is completed in accordance with Schedule 6.2 – Planning Scheme Policy 1 – Land Development Standards of the <i>Goondiwindi Region Planning Scheme 2018 (Version 2)</i> to the satisfaction of and at no cost to Council.</p> <p>Control procedures are to be established to ensure sediment from the site is not deposited off site. The developer shall ensure no increase in any silt loads or contaminants in overland flow from the site during the development process and after development has been completed.</p>
AVOIDING NUISANCE	
20.	<p>At all times while the use continues, the development shall be conducted in accordance with the provisions of the <i>Environmental Protection Act 1994</i> (the Act) and all relevant regulations and standards under that Act. All necessary licences under the Act shall be obtained and shall be maintained at all times while the use continues.</p>
21.	<p>At all times while the use continues it shall be operated in such a manner as to ensure that no nuisance shall arise to surrounding premises as a result of dust, noise, lighting, odour, vibration, rubbish, contaminants, stormwater discharge or siltation or any other potentially detrimental impact.</p>
22.	<p>All external lighting is to be compliant with AS/NZS 4282-2019 “<i>Control of obtrusive effects of outdoor lighting</i>”.</p>
23.	<p>At all times while the use continues, provision must be made on site for the collection of general refuse in covered waste containers with a capacity sufficient for the use.</p> <p>Waste receptacles shall be placed in a screened area. The site must maintain a general tidy appearance.</p>
24.	<p>The operator shall be responsible for mitigating any complaints arising from on-site operations.</p>
25.	<p>Construction works must occur so they do not cause unreasonable interference with the amenity of adjoining premises.</p> <p>The site must be kept in a clean and tidy state at all times during construction.</p>
26.	<p>At all times while the use continues, any air conditioned equipment shall be acoustically screened to ensure noise levels do not exceed 5 dB(A) above the background noise level measured at the boundaries of the subject site.</p>

DEVELOPER'S RESPONSIBILITIES	
27.	Any alteration or damage to roads and/or public infrastructure that is attributable to the progress of works or vehicles associated with the development of the site shall be repaired to Council's satisfaction or the cost of repairs paid to Council.
28.	All contractors and subcontractors shall hold current, relevant and appropriate qualifications and insurances to carry out the works.
29.	All costs reasonably associated with the approved development, unless there is specific agreement by other parties to meet these costs, shall be met by the developer.
30.	At all times while the use continues, all requirements of the conditions of the development approval must be maintained.
COMMENCEMENT OF USE	
31.	<p>At its discretion, Council may accept bonds or other securities to ensure completion of specified development approval conditions or Council may accept cash payments for Council to undertake the necessary work to ensure completion of specified development approval conditions.</p> <p>It may be necessary for Council to use such bonds for the completion of outstanding works without a specific timeframe agreed.</p> <p>The decision to accept bonds or other securities to satisfy a condition will be that of Council, not the applicant.</p>
32.	<p>Council must be notified in writing of the date of the commencement of the use within 14 days of commencement.</p> <p>This approval will lapse if the use has not commenced within six years of the date the development approval takes effect, in accordance with the provisions contained in sections 85(i)(a) of the <i>Planning Act 2016</i>.</p> <p>Section 86 of the <i>Planning Act 2016</i> sets out how an extension to the period of approval can be requested.</p>
33.	A letter outlining and demonstrating that conditions have been, or will be, complied with shall be submitted to Council and approved by a relevant Officer of Council prior to commencement of the use at each relevant stage. Council Officers may require a physical inspection to confirm that all conditions have been satisfied to relevant standards.

PLEASE READ CAREFULLY - NOTES AND ADVICE	
	<p><i>When approval takes effect</i></p> <p>This approval takes effect in accordance with section 85 of the <i>Planning Act 2016</i>.</p> <p><i>When approval lapses</i></p> <p>This approval will lapse if the change of use has not occurred within the following period, in accordance with the provisions contained in section 85(i)(a) of the <i>Planning Act 2016</i>.</p> <p>(a) If no period stated – 6 years after the approval starts to have effect. Section 86 of the <i>Planning Act 2016</i> sets out how an extension to the period of approval can be requested.</p>
	<p>Infrastructure charges as outlined in the Infrastructure Charges Notice included in Attachment 3 shall be paid prior to the commencement of the use.</p>
	<p>This approval in no way removes the duty of care responsibility of the applicant under the <i>Aboriginal Cultural Heritage Act 2003</i>. Pursuant to Section 23(1) of the <i>Aboriginal Cultural Heritage Act 2003</i>, a person who carries out an activity must take all reasonable and practicable measures to ensure the activity does not harm Aboriginal cultural heritage (the "cultural heritage duty of care").</p>
	<p>This approval in no way authorises the clearing of native vegetation protected under the <i>Vegetation Management Act 1999</i>.</p>
	<p>The approved development does not authorise any deviation from the applicable Australian Standards nor from the application of any laws, including laws covering work place health and safety.</p>
	<p>Building Approval is to be obtained in accordance with the <i>Planning Act 2016</i> for a Change of Classification of Building from Class 10a to Class 7b or Class 8, to allow the use of the existing building for industrial purposes.</p> <p>The application must be submitted to a Building Certifier with the appropriate forms, plans and fees associated with this application. Building works and modification of the existing building may be required to be undertaken as part of the approval so as to accord with the requirements of the <i>Building Act 1975</i>.</p>



Attachment 2 – Approved Plans



GOONDIWINDI REGIONAL COUNCIL
 Approved Plan referred to in Council's Decision Notice
 Council Reference: 23/20
 Dated: 15-08-2023
 Signed: R.M.M.O.
 Print Name: Ronnie McMahon
 (Under Delegation) ASSESSMENT MANAGER

7
 RP167463

61
 SP200619

5
 RP167463

STORMWATER
 OVERFLOW
 TO TABLE DRAIN

LEICHHARDT HIGHWAY

EXISTING LANDSCAPING

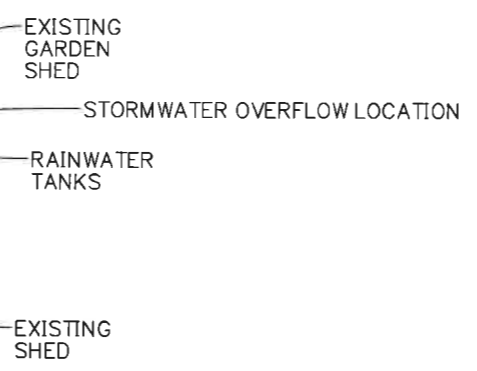
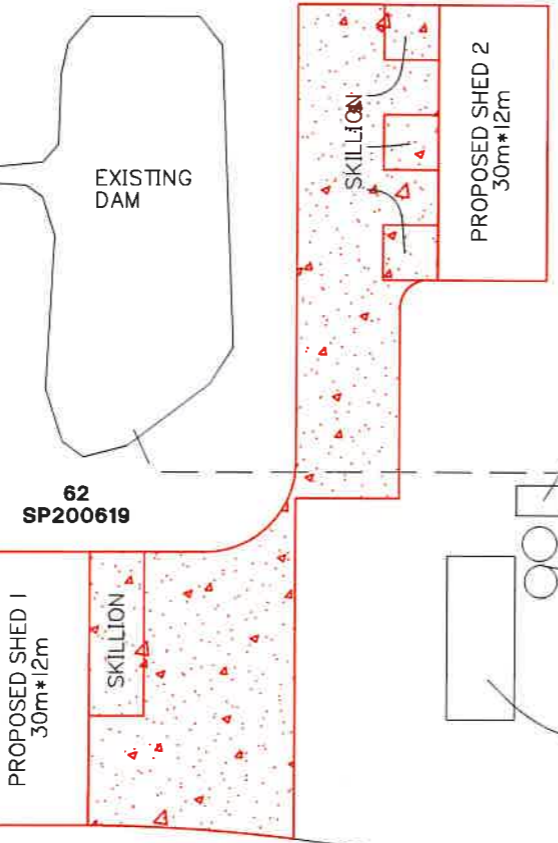

GLASSER STREET

EXISTING WATER METER

Note:
 This plan was prepared for WILLIAM BOYD to accompany a Material Change of Use application to the GOONDIWINDI REGIONAL COUNCIL and should not be used for any other purpose. This note is an integral part of this plan

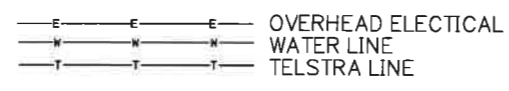

NOTE:
 SHED 1 = 360 sqm
 SHED 2 = 360 sqm
 HARDSTAND AREA = 2890 sqm



SCALE 1: 800

WILLIAM BOYD
 SMK QLD

Goondiwindi · Brisbane · Gold Coast · Toowoomba · Gatton
 Phone: (07) 4671 2445 Email: admin@smkqld.com.au

SITE PLAN FOR MCU APPLICATION
 LOT 62 SP200619

23041 A3 23041-1
 SCALE Horiz 1:800

Surveyor JFJ 31/3/2023 2:57PM C:\Users\User\Dropbox\JOBS\2023\23041 WILLIAM BOYD MCU GLASSER STREET\23041-1.pro

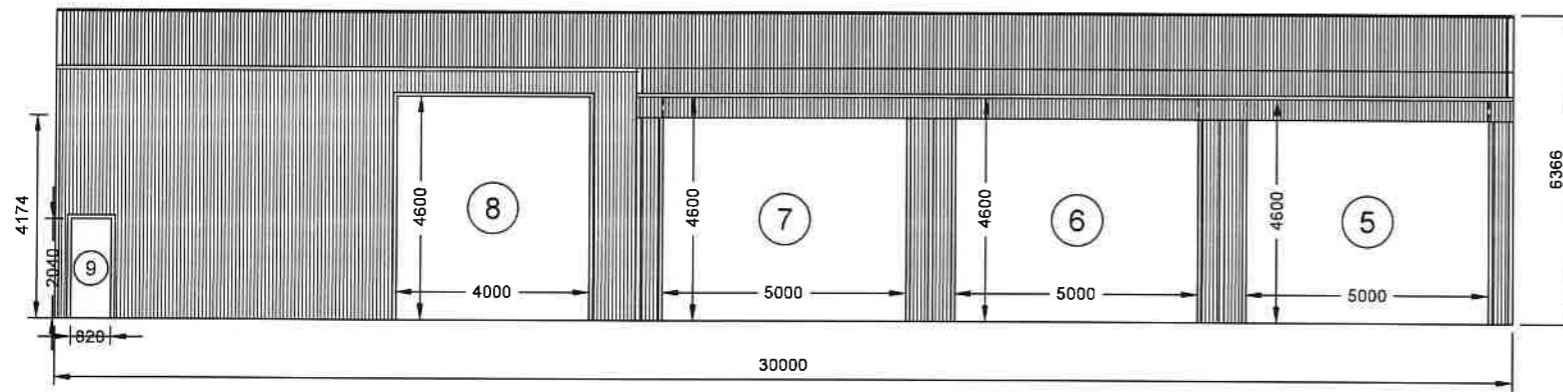

2 LEFT ELEVATION
SCALE: 1:150

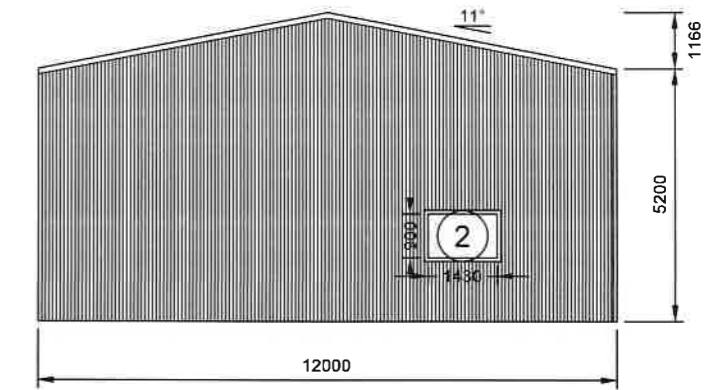

3 REAR ELEVATION
SCALE: 1:150

FRAME #6

GOONDIWINDI REGIONAL COUNCIL
Approved Plan referred to in Council's Decision Notice
Council Reference: 23/20
Dated: 15-08-2023
Signed: R.M.M.
Print Name: Ronnie McMahon
(Under Delegation) ASSESSMENT MANAGER

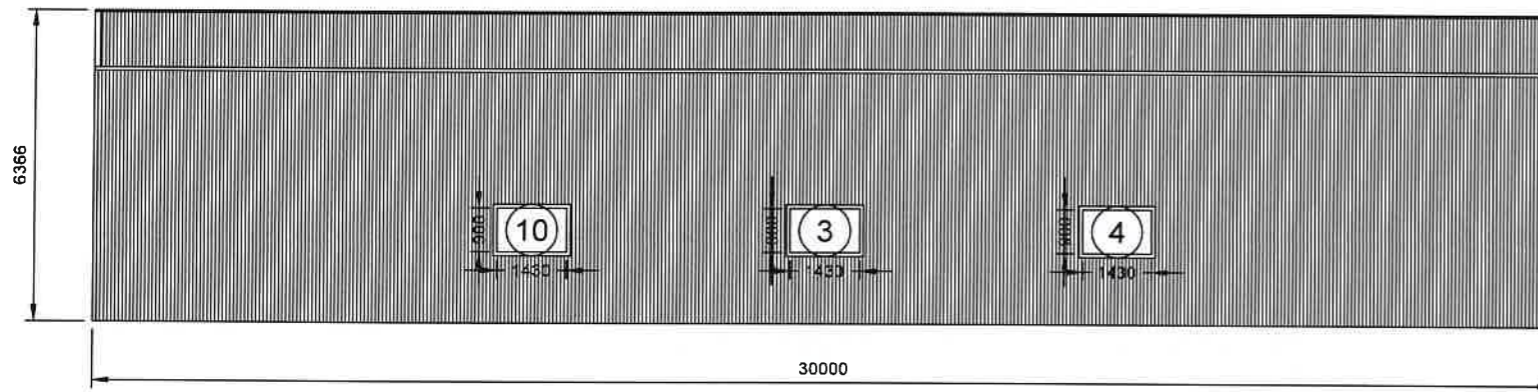

1 RIGHT ELEVATION
SCALE: 1:150

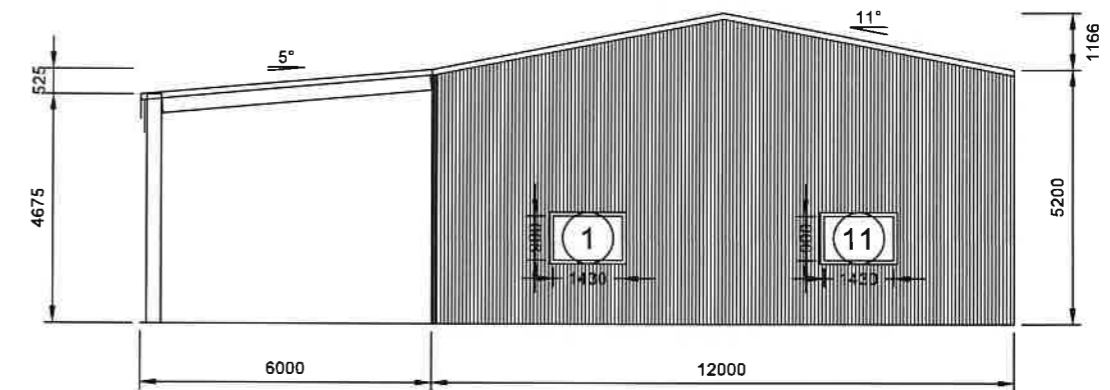

4 FRONT ELEVATION
SCALE: 1:150

FRAME #1

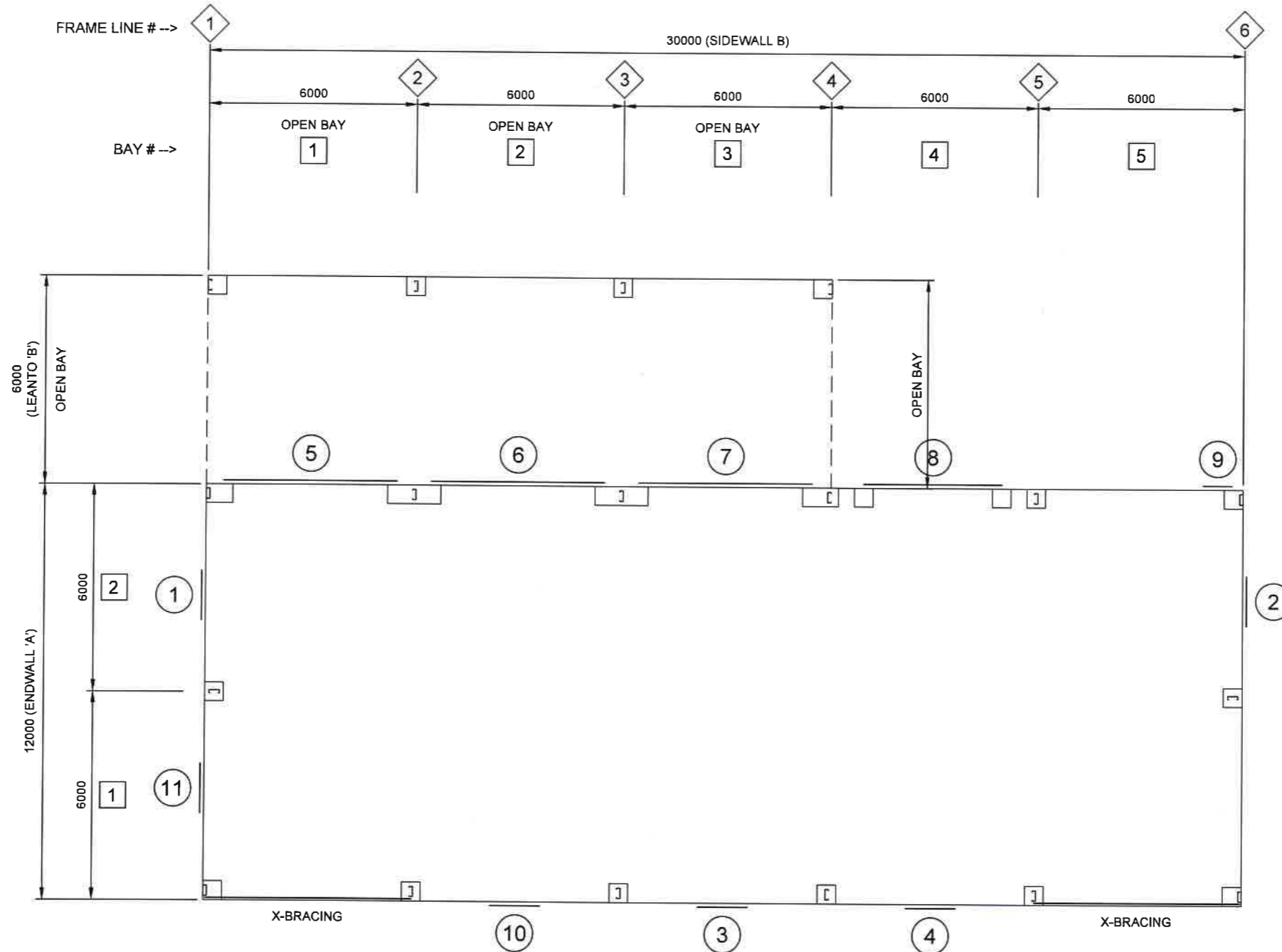

GOONDIWINDI REGIONAL COUNCIL
 Approved Plan referred to in Council's Decision Notice
 Council Reference: 23/20
 Dated: 15-08-2023
 Signed: *R.M.M.*
 Print Name: Ronnie McMahon
 (Under Delegation) ASSESSMENT MANAGER

1 FLOOR PLAN
 SCALE: 1:150

Council Reference: 23/20
Dated: 15-08-2023
Signed: RM McMahon
Print Name: Ronnie McMahon
(Under Delegation) ASSESSMENT MANAGER

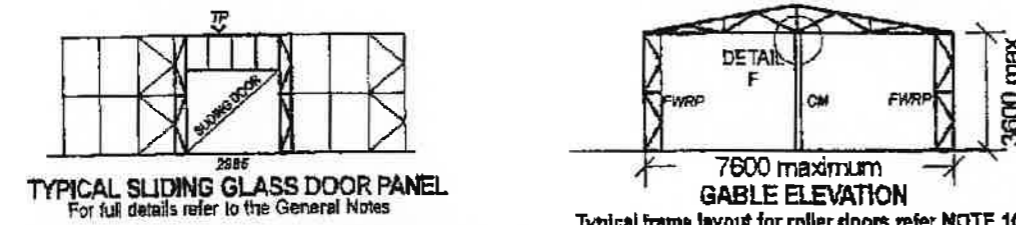
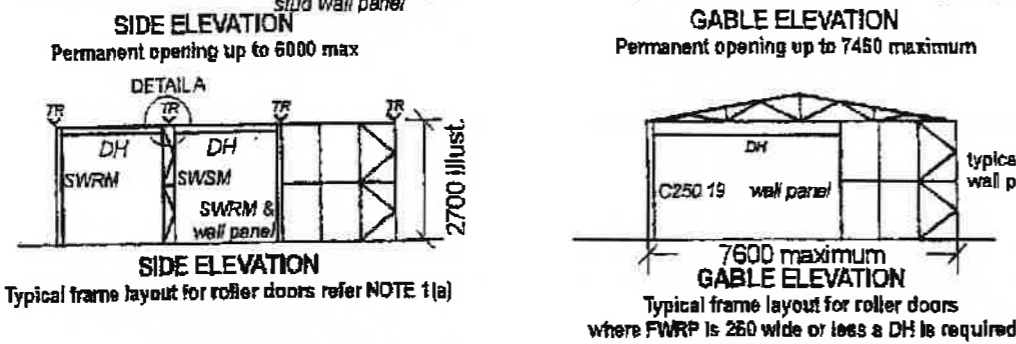
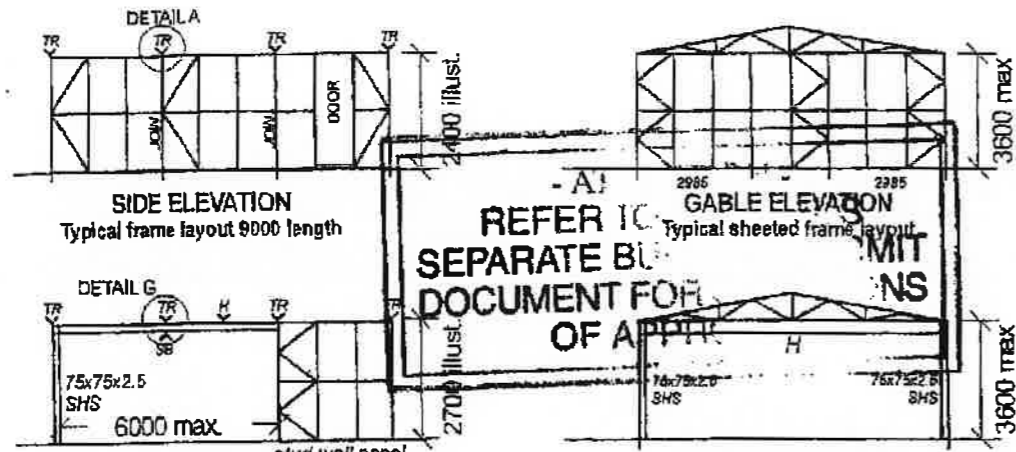

NOTE: Elevations shown illustrate examples only of roller door openings & locations. Opening size & location may vary with customer requirements, but structural & fixing details remain unchanged.

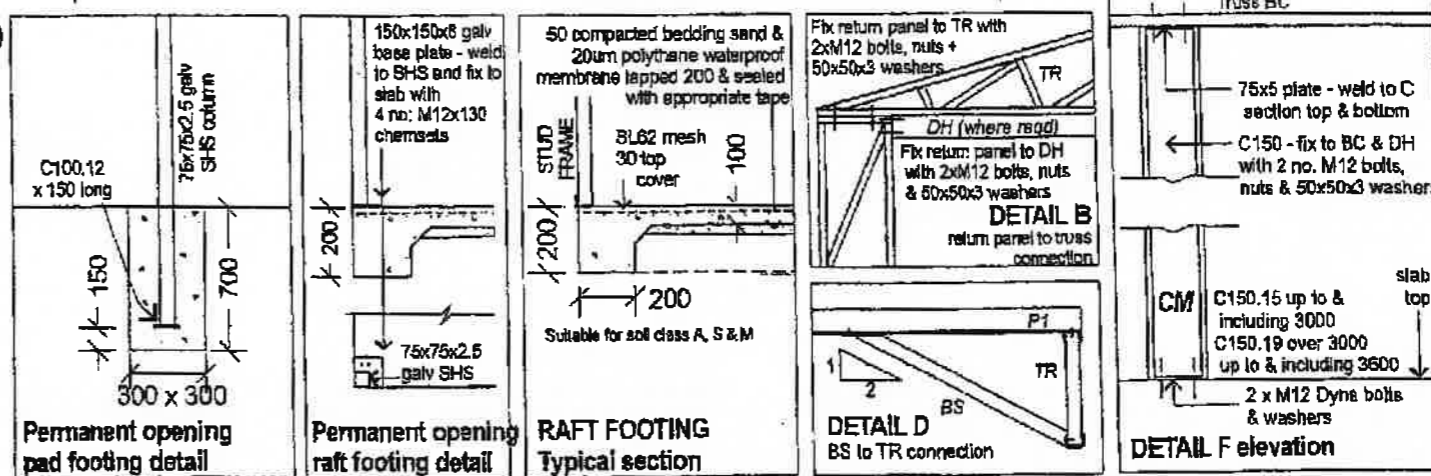
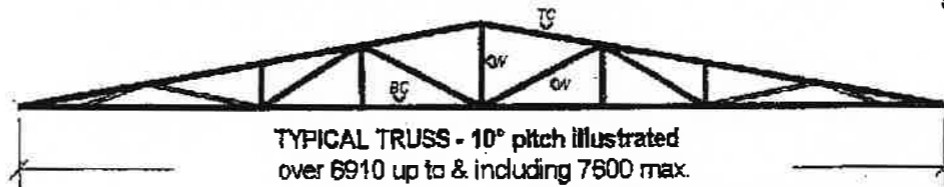
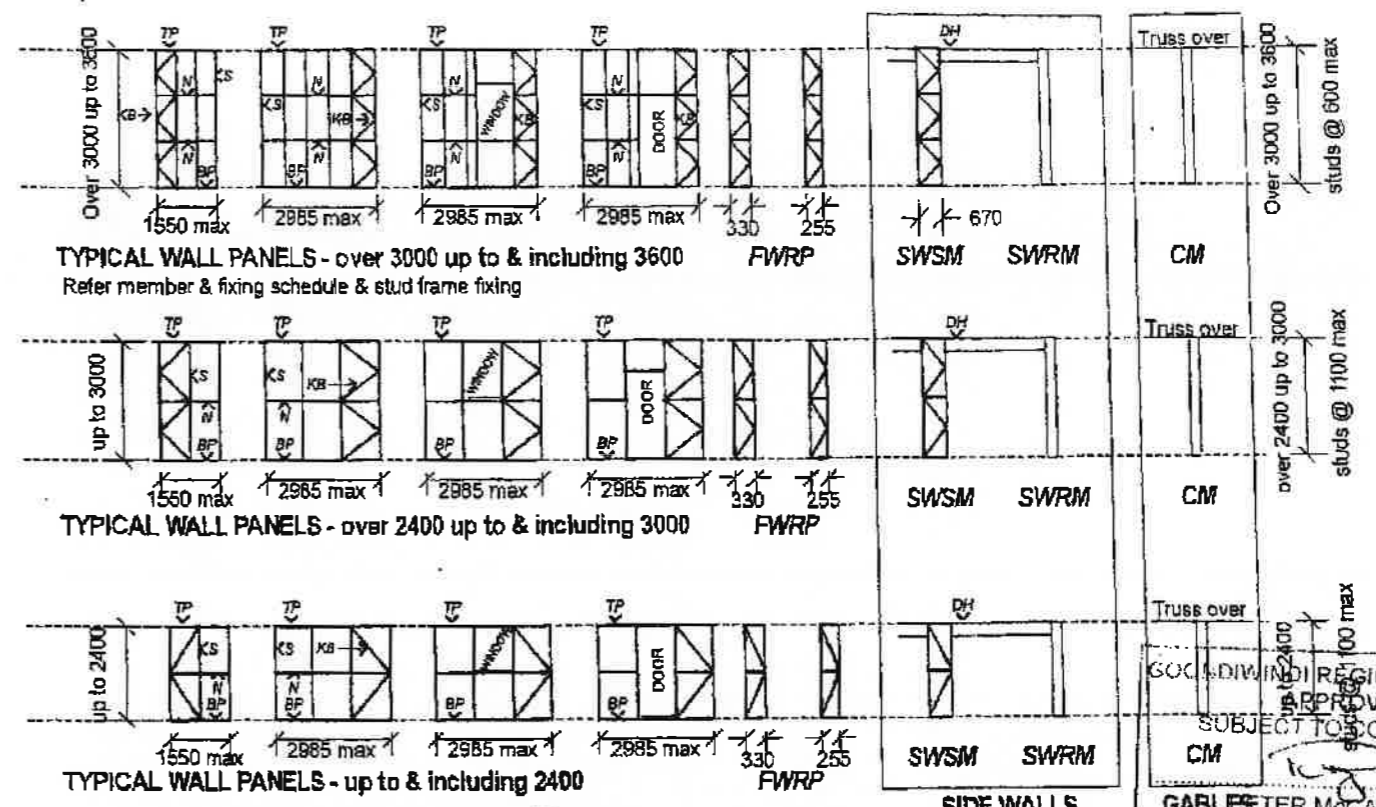
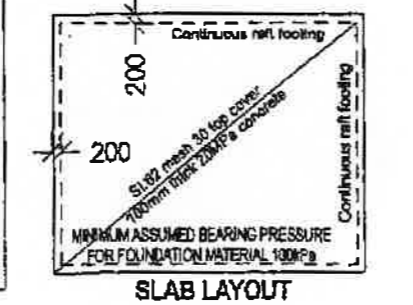
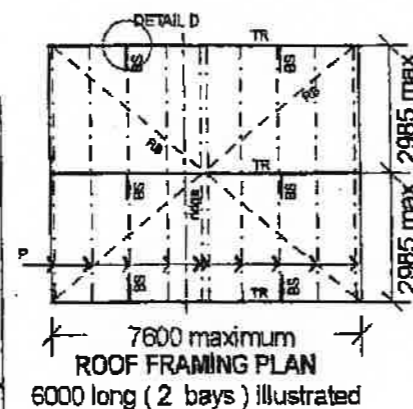
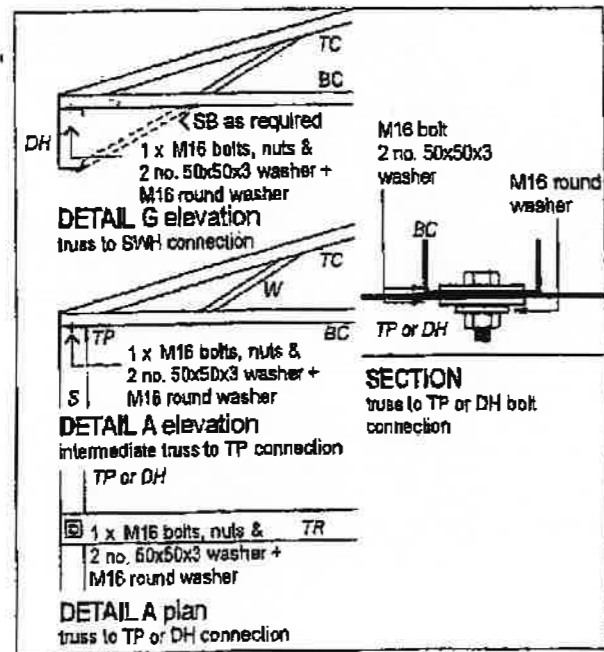

7-0207 UPDATED FOR LTC ENGINEERS CERTIFICATION

no: 7-0207 date: 7-02-2007 revision: N/S

Verified: N/S Date: JAN 2007

Scale: NTS

Date: 7-02-2007 Drawn: RL

Approved: [Signature] Date: 9/2/07

TITAN
GARAGES & SHEDS
TITAN ENTERPRISES (OLD) PTY LTD
ACN 056 596 082
155-159 Magnesium Drv, Crestmead, 4132
Ph: 07 3803 6077 Fax: 07 3803 6971

GOLDSTAR Series
Type 7600 - N3

FRAMING DETAILS

TE 138-03.1

COPYRIGHT ©2007

GOONDIWINDI REGIONAL COUNCIL
APPROVED
SUBJECT TO CONDITIONS

GABRIEL MCCASHNEY
BUILDING CERTIFIER, ACC. NO. A
DATE: 14 MAR 2014
SA NO: 626/14

13 DEC 2013

STRUCTURAL DETAIL CONSULTANT
THIS CERTIFICATION EXPIRES ON 01 FEB 14



Attachment 3 – Infrastructure Charges Notice





Goondiwindi Customer Service
Centre
4 McLean Street
Goondiwindi
Inglewood Customer Service
Centre
18 Elizabeth Street
Inglewood

Locked Mail Bag 7
Inglewood QLD 4387

Telephone: 07 4671 7400
Fax: 07 4671 7433

Email: mail@grc.qld.gov.au

Infrastructure Charges Notice

Address	Glasser Street, Goondiwindi
Owner	William Martyn Boyd
Applicant	SMK QLD Pty Ltd for William Boyd
Application No.	23/20
Lot and Survey Plan	Lot 62 on SP200619
Date	15 August 2023
Approval	Development Permit – Material Change of Use

Development Application Details
"Industry activities" – "Low Impact Industry", "Warehouse" and "Transport Depot"

Type of Charge	Charge Area (A, B, C, D or E)	Charge Amount (\$)	Demand	Charge (\$)
Industry Uses	A	\$8 per m ² of GFA	857	\$6,856
		\$1 per m ² of impervious area	4701	\$4,701

Due Date	When the change of use occurs	Total Charge (\$)	\$11,557
Charge to be paid to	Goondiwindi Regional Council		
Lapse Date	14 August 2029		

Authorised by:

Print Name: **Mrs Ronnie McMahon**
Manager of Planning Services

In accordance the Planning Act 2016

Office Use – Receipt Number
Charges – 1250-1150-0000





Attachment 4 – Notice about decision - Statement of reasons



Notice about decision - Statement of reasons

The following information is provided in accordance with section 63 (5) of the Planning Act 2016 and must be published on the assessment managers website.

The development application for "Industry activities" – "Low Impact Industry", "Warehouse" and "Transport Depot"

23/20

Glasser Street, Goondiwindi

Lot 62 on SP200619

On 8 August 2023, the above development application was:

- approved in full or
 approved in part for _____ or
 approved in full with conditions or
 approved in part for _____, with conditions or
 refused.

1. Reasons for the decision

The reasons for this decision are:

- Having regard to the relevant criteria in the Goondiwindi Region Planning Scheme 2018, the proposed development satisfied all relevant criteria, and was approved subject to appropriate, relevant and reasonable conditions.

2. Assessment benchmarks

The following are the benchmarks applying for this development:

Benchmarks applying for the development	Benchmark reference
Mixed Use Zone Code	PO1-PO5
Transport & Infrastructure Code	PO1-PO15
Natural Resources Overlay Code	PO5-PO8
Flood Hazard Overlay Code	PO1-PO4

3. Compliance with benchmarks

Benchmark reference	Reasons for the approval despite non-compliance with benchmark
Mixed Use Zone Code	
<p>AO2.1 Site cover does not exceed 10%.</p> <p>Where for a <i>domestic outbuilding</i>: AO2.2 <i>Domestic outbuildings</i> on lots fronting the Leichardt Highway do not exceed a cumulative <i>gross floor area</i> of 140m².</p>	<p>Alternative Solution</p> <p>Site cover is approximately 11%. The non-compliance is considered to be negligible and the scale of development on the site remains generally low intensity.</p>
<p>Where for <i>Industry activities</i>: AO3.1 Operating hours are limited to between the hours of 7:00am and 6:00pm</p> <p>AO3.2 The loading and unloading of goods is limited to between the hours of: (a) 8:00am and 6:00pm, Monday to Friday; (b) 8:00am and 12:00pm, Saturdays; and (c) no loading and unloading occurs on Sundays and public holidays.</p>	<p>Alternative Solution</p> <p>The applicant proposes operating and loading/unloading hours to be 6:30am to 5:00pm, Monday to Friday. The proposed alternative is not a significant variation and is not considered outside the reasonable amenity expectations of residences in the area.</p>
Transport & Infrastructure Code	
<p>AO2 Parking is provided on the site in accordance with the requirements identified in Table 9.4.4.2 - Car parking generation rates and service vehicle requirements.</p> <p>Note—where for a <i>supermarket</i> or <i>shopping centre</i> including a <i>supermarket</i> in the Central business district precinct or Pratten Street precinct of the Centre Zone or the Callandoon Street precinct or Marshall Street precinct of the General residential zone, a Traffic and Car Parking Impact Assessment and Street Improvement Plan is undertaken in support of any development application seeking car parking concessions.</p> <p>OR Where development is for a material change of use involving no building work or <i>minor building work</i>, the existing number of car parking spaces on the premises is maintained.</p>	<p>Condition to Comply</p> <p>It is stated in the application that the number of car parking spaces will be adequate for the proposed use, however no parking spaces are shown on the submitted plans..</p> <p>Table 9.4.4.2 requires 22 car parking spaces be provided. Conditions will be applied to require 22 car parking spaces to be provided on the site..</p>

4. Relevant matters for impact assessable development

5. Matters raised in submissions for impact assessable development

6. Matters prescribed by Regulation



Attachment 5 – *Planning Act 2016* Extracts



**EXTRACT FROM PLANNING ACT 2016
RELATING TO APPEAL RIGHTS**

Chapter 6 Dispute Resolution, Part 1 Appeal Rights

229 Appeals to tribunal or P&E Court

(1) Schedule 1 states—

(a) matters that may be appealed to—

(i) either a tribunal or the P&E Court; or

(ii) only a tribunal; or

(iii) only the P&E Court; and

(b) the person—

(i) who may appeal a matter (the **appellant**); and

(ii) who is a respondent in an appeal of the matter; and

(iii) who is a co-respondent in an appeal of the matter; and

(iv) who may elect to be a co-respondent in an appeal of the matter.

(2) An appellant may start an appeal within the appeal period.

(3) The **appeal period** is—

(a) for an appeal by a building advisory agency—10 business days after a decision notice for the decision is given to the agency; or

(b) for an appeal against a deemed refusal— at any time after the deemed refusal happens; or

(c) for an appeal against a decision of the Minister, under chapter 7, part 4, to register premises or to renew the registration of premises—20 business days after a notice is published under section 269(3)(a) or (4); or

(d) for an appeal against an infrastructure charges notice—20 business days after the infrastructure charges notice is given to the person; or

(e) for an appeal about a deemed approval of a development application for which a decision notice has not been given—30 business days after the applicant gives the

deemed approval notice to the assessment manager; or

(f) for any other appeal—20 business days after a notice of the decision for the matter, including an enforcement notice, is given to the person.

Note—

See the P&E Court Act for the court's power to extend the appeal period.

(4) Each respondent and co-respondent for an appeal may be heard in the appeal.

(5) If an appeal is only about a referral agency's response, the assessment manager may apply to the tribunal or P&E Court to withdraw from the appeal.

(6) To remove any doubt, it is declared that an appeal against an infrastructure charges notice must not be about—

(a) the adopted charge itself; or

(b) for a decision about an offset or refund—

(i) the establishment cost of trunk infrastructure identified in a LGIP; or

(ii) the cost of infrastructure decided using the method included in the local government's charges resolution.

230 Notice of appeal

(1) An appellant starts an appeal by lodging, with the registrar of the tribunal or P&E Court, a notice of appeal that—

(a) is in the approved form; and

(b) succinctly states the grounds of the appeal.

(2) The notice of appeal must be accompanied by the required fee.

(3) The appellant or, for an appeal to a tribunal, the registrar must, within the service period, give a copy of the notice of appeal to—

(a) the respondent for the appeal; and

(b) each co-respondent for the appeal; and

(c) for an appeal about a development application under schedule 1, table 1, item 1—each

principal submitter for the development application; and

(d) for an appeal about a change application under schedule 1, table 1, item 2—each principal submitter for the change application; and

(e) each person who may elect to become a co-respondent for the appeal, other than an eligible submitter who is not a principal submitter in an appeal under paragraph (c) or (d); and

(f) for an appeal to the P&E Court—the chief executive; and

(g) for an appeal to a tribunal under another Act—any other person who the registrar considers appropriate.

(4) The **service period** is—

(a) if a submitter or advice agency started the appeal in the P&E Court—2 business days after the appeal is started; or

(b) otherwise—10 business days after the appeal is started.

(5) A notice of appeal given to a person who may elect to be a co-respondent must state the effect of subsection (6).

(6) A person elects to be a co-respondent by filing a notice of election, in the approved form, within 10 business days after the notice of appeal is given to the person.

231 Other appeals

(1) Subject to this chapter, schedule 1 and the P&E Court Act, unless the Supreme Court decides a decision or other matter under this Act is affected by jurisdictional error, the decision or matter is non-appealable.

(2) The Judicial Review Act 1991, part 5 applies to the decision or matter to the extent it is affected by jurisdictional error.

(3) A person who, but for subsection (1) could have made an application under the Judicial Review Act 1991 in relation to the decision or matter, may apply under part 4 of that Act for a statement of reasons in relation to the decision or matter.

(4) In this section—

decision includes—

(a) conduct engaged in for the purpose of making a decision; and

(b) other conduct that relates to the making of a decision; and

(c) the making of a decision or the failure to make a decision; and

(d) a purported decision; and

(e) a deemed refusal.

non-appealable, for a decision or matter, means the decision or matter—

(a) is final and conclusive; and

(b) may not be challenged, appealed against, reviewed, quashed, set aside or called into question in any other way under the Judicial Review Act 1991 or otherwise, whether by the Supreme Court, another court, a tribunal or another entity; and

(c) is not subject to any declaratory, injunctive or other order of the Supreme Court, another court, a tribunal or another entity on any ground.

232 Rules of the P&E Court

(1) A person who is appealing to the P&E Court must comply with the rules of the court that apply to the appeal.

(2) However, the P&E Court may hear and decide an appeal even if the person has not complied with rules of the P&E Court.

Part 2 Development tribunal

Division 1 General

233 Appointment of referees

(1) The Minister, or chief executive, (the appointer) may appoint a person to be a referee, by an appointment notice, if the appointer considers the person—

(a) has the qualifications or experience prescribed by regulation; and

(b) has demonstrated an ability—

(i) to negotiate and mediate outcomes between parties to a proceeding; and

(ii) to apply the principles of natural justice; and

(iii) to analyse complex technical issues; and

(iv) to communicate effectively, including, for example, to write informed succinct and well-organised decisions, reports, submissions or other documents.

(2) The appointer may—

(a) appoint a referee for the term, of not more than 3 years, stated in the appointment notice; and

(b) reappoint a referee, by notice, for further terms of not more than 3 years.

(3) If an appointer appoints a public service officer as a referee, the officer holds the appointment concurrently with any other appointment that the officer holds in the public service.

(4) A referee must not sit on a tribunal unless the referee has given a declaration, in the approved form and signed by the referee, to the chief executive.

(5) The appointer may cancel a referee's appointment at any time by giving a notice, signed by the appointer, to the referee.

(6) A referee may resign the referee's appointment at any time by giving a notice, signed by the referee, to the appointer.

(7) In this section—

appointment notice means—

(a) if the Minister gives the notice—a gazette notice; or

(b) if the chief executive gives the notice—a notice given to the person appointed as a referee.

234 Referee with conflict of interest

(1) This section applies if the chief executive informs a referee that the chief executive proposes to appoint the referee as a tribunal member, and either or both of the following apply—

(a) the tribunal is to hear a matter about premises—

(i) the referee owns; or

(ii) for which the referee was, is, or is to be, an architect, builder, drainer, engineer, planner, plumber, plumbing inspector, certifier, site evaluator or soil assessor; or

(iii) for which the referee has been, is, or will be, engaged by any party in the referee's capacity as an accountant, lawyer or other professional; or

(iv) situated or to be situated in the area of a local government of which the referee is an officer, employee or councillor;

(b) the referee has a direct or indirect personal interest in a matter to be considered by the tribunal, and the interest could conflict with the proper performance of the referee's functions for the tribunal's consideration of the matter.

(2) However, this section does not apply to a referee only because the referee previously acted in relation to the preparation of a relevant local planning instrument.

(3) The referee must notify the chief executive that this section applies to the referee, and on doing so, the chief executive must not appoint the referee to the tribunal.

(4) If a tribunal member is, or becomes, aware the member should not have been appointed to the tribunal, the member must not act, or continue to act, as a member of the tribunal.

235 Establishing development tribunal

(1) The chief executive may at any time establish a tribunal, consisting of up to 5 referees, for tribunal proceedings.

(2) The chief executive may appoint a referee for tribunal proceedings if the chief executive considers the referee has the qualifications or experience for the proceedings.

(3) The chief executive must appoint a referee as the chairperson for each tribunal.

(4) A regulation may specify the qualifications or experience required for particular proceedings.

(5) After a tribunal is established, the tribunal's membership must not be changed.

236 Remuneration

A tribunal member must be paid the remuneration the Governor in Council decides.

237 Tribunal proceedings

- (1) *A tribunal must ensure all persons before the tribunal are afforded natural justice.*
- (2) *A tribunal must make its decisions in a timely way.*
- (3) *A tribunal may—*
 - (a) *conduct its business as the tribunal considers appropriate, subject to a regulation made for this section; and*
 - (b) *sit at the times and places the tribunal decides; and*
 - (c) *hear an appeal and application for a declaration together; and*
 - (d) *hear 2 or more appeals or applications for a declaration together.*
- (4) *A regulation may provide for—*
 - (a) *the way in which a tribunal is to operate, including the qualifications of the chairperson of the tribunal for particular proceedings; or*
 - (b) *the required fee for tribunal proceedings.*

238 Registrar and other officers

- (1) *The chief executive may, by gazette notice, appoint—*
 - (a) *a registrar; and*
 - (b) *other officers (including persons who are public service officers) as the chief executive considers appropriate to help a tribunal perform its functions.*
- (2) *A person may hold the appointment or assist concurrently with any other public service appointment that the person holds.*

Division 2 Applications for declarations

239 Starting proceedings for declarations

- (1) *A person may start proceedings for a declaration by a tribunal by filing an application, in the approved form, with the registrar.*
- (2) *The application must be accompanied by the required fee.*

240 Application for declaration about making of development application

- (1) *The following persons may start proceedings for a declaration about whether a development application is properly made—*
 - (a) *the applicant;*
 - (b) *the assessment manager.*
- (2) *However, a person may not seek a declaration under this section about whether a development application is accompanied by the written consent of the owner of the premises to the application.*
- (3) *The proceedings must be started by—*
 - (a) *the applicant within 20 business days after receiving notice from the assessment manager, under the development assessment rules, that the development application is not properly made; or*
 - (b) *the assessment manager within 10 business days after receiving the development application.*
- (4) *The registrar must, within 10 business days after the proceedings start, give notice of the proceedings to the respondent as a party to the proceedings.*
- (5) *In this section—*

respondent means—

- (a) *if the applicant started the proceedings—the assessment manager; or*
- (b) *if the assessment manager started the proceedings—the applicant.*

241 Application for declaration about change to development approval

- (1) *This section applies to a change application for a development approval if—*
 - (a) *the approval is for a material change of use of premises that involves the use of a classified building; and*
 - (b) *the responsible entity for the change application is not the P&E Court.*
- (2) *The applicant, or responsible entity, for the change application may start proceedings for a*

declaration about whether the proposed change to the approval is a minor change.

(3) The registrar must, within 10 business days after the proceedings start, give notice of the proceedings to the respondent as a party to the proceedings.

(4) In this section—

respondent means—

(a) if the applicant started the proceedings—the responsible entity; or

(b) if the responsible entity started the proceedings—the applicant.

Division 3 Tribunal proceedings for appeals and declarations

242 Action when proceedings start

If a document starting tribunal proceedings is filed with the registrar within the period required under this Act, and is accompanied by the required fee, the chief executive must—

(a) establish a tribunal for the proceedings; and

(b) appoint 1 of the referees for the tribunal as the tribunal's chairperson, in the way required under a regulation; and

(c) give notice of the establishment of the tribunal to each party to the proceedings.

243 Chief executive excusing noncompliance

(1) This section applies if—

(a) the registrar receives a document purporting to start tribunal proceedings, accompanied by the required fee; and

(b) the document does not comply with any requirement under this Act for validly starting the proceedings.

(2) The chief executive must consider the document and decide whether or not it is reasonable in the circumstances to excuse the noncompliance (because it would not cause substantial injustice in the proceedings, for example).

(3) If the chief executive decides not to excuse the noncompliance, the chief executive must give a notice stating that the document is of no effect,

because of the noncompliance, to the person who filed the document.

(4) The chief executive must give the notice within 10 business days after the document is given to the chief executive.

(5) If the chief executive does excuse the noncompliance, the chief executive may act under section 242 as if the noncompliance had not happened.

244 Ending tribunal proceedings or establishing new tribunal

(1) The chief executive may decide not to establish a tribunal when a document starting tribunal proceedings is filed, if the chief executive considers it is not reasonably practicable to establish a tribunal.

Examples of when it is not reasonably practicable to establish a tribunal—

- there are no qualified referees or insufficient qualified referees because of a conflict of interest

- the referees who are available will not be able to decide the proceedings in a timely way

(2) If the chief executive considers a tribunal established for tribunal proceedings—

(a) does not have the expertise to hear or decide the proceedings; or

(b) is not able to make a decision for proceedings (because of a tribunal member's conflict of interest, for example); the chief executive may decide to suspend the proceedings and establish another tribunal, complying with section 242(c), to hear or re-hear the proceedings.

(3) However, the chief executive may instead decide to end the proceedings if the chief executive considers it is not reasonably practicable to establish another tribunal to hear or re-hear the proceedings.

(4) If the chief executive makes a decision under subsection (1) or (3), the chief executive must give a decision notice about the decision to the parties to the proceedings.

(5) Any period for starting proceedings in the P&E Court, for the matter that is the subject of the tribunal proceedings, starts again when the chief

executive gives the decision notice to the party who started the proceedings.

- (6) The decision notice must state the effect of subsection (5).

245 Refunding fees

The chief executive may, but need not, refund all or part of the fee paid to start proceedings if the chief executive decides under section 244—

- (a) not to establish a tribunal; or
- (b) to end the proceedings.

246 Further material for tribunal proceedings

- (1) The registrar may, at any time, ask a person to give the registrar any information that the registrar reasonably requires for the proceedings.

Examples of information that the registrar may require—

- material about the proceedings (plans, for example)
 - information to help the chief executive decide whether to excuse noncompliance under section 243
 - for a deemed refusal—a statement of the reasons why the entity responsible for deciding the application had not decided the application during the period for deciding the application.
- (2) The person must give the information to the registrar within 10 business days after the registrar asks for the information.

247 Representation of Minister if State interest involved

If, before tribunal proceedings are decided, the Minister decides the proceedings involve a State interest, the Minister may be represented in the proceedings.

248 Representation of parties at hearing

A party to tribunal proceedings may appear—

- (a) in person; or
- (b) by an agent who is not a lawyer.

249 Conduct of tribunal proceedings

- (1) Subject to section 237, the chairperson of a tribunal must decide how tribunal proceedings are to be conducted.

- (2) The tribunal may decide the proceedings on submissions if the parties agree.

- (3) If the proceedings are to be decided on submissions, the tribunal must give all parties a notice asking for the submissions to be made to the tribunal within a stated reasonable period.

- (4) Otherwise, the tribunal must give notice of the time and place of the hearing to all parties.

- (5) The tribunal may decide the proceedings without a party's submission (written or oral) if—

(a) for proceedings to be decided on submissions—the party's submission is not received within the time stated in the notice given under subsection (3); or

(b) for proceedings to be decided by hearing—the person, or the person's agent, does not appear at the hearing.

- (6) When hearing proceedings, the tribunal—

(a) need not proceed in a formal way; and

(b) is not bound by the rules of evidence; and

(c) may inform itself in the way it considers appropriate; and

(d) may seek the views of any person; and

(e) must ensure all persons appearing before the tribunal have a reasonable opportunity to be heard; and

(f) may prohibit or regulate questioning in the hearing.

- (7) If, because of the time available for the proceedings, a person does not have an opportunity to be heard, or fully heard, the person may make a submission to the tribunal.

250 Tribunal directions or orders

A tribunal may, at any time during tribunal proceedings, make any direction or order that the tribunal considers appropriate.

Examples of directions—

- a direction to an applicant about how to make their development application comply with this Act
- a direction to an assessment manager to assess a development application, even though the referral agency's response to the assessment manager was to refuse the application

251 Matters tribunal may consider

- (1) This section applies to tribunal proceedings about—
 - (a) a development application or change application; or
 - (b) an application or request (however called) under the Building Act or the Plumbing and Drainage Act.
- (2) The tribunal must decide the proceedings based on the laws in effect when—
 - (a) the application or request was properly made; or
 - (b) if the application or request was not required to be properly made—the application or request was made.
- (3) However, the tribunal may give the weight that the tribunal considers appropriate, in the circumstances, to any new laws.

252 Deciding no jurisdiction for tribunal proceedings

- (1) A tribunal may decide that the tribunal has no jurisdiction for tribunal proceedings, at any time before the proceedings are decided—
 - (a) on the tribunal's initiative; or
 - (b) on the application of a party.
- (2) If the tribunal decides that the tribunal has no jurisdiction, the tribunal must give a decision notice about the decision to all parties to the proceedings.
- (3) Any period for starting proceedings in the P&E Court, for the matter that is the subject of the tribunal proceedings, starts again when the tribunal gives the decision notice to the party who started the proceedings.

- (4) The decision notice must state the effect of subsection (3).
- (5) If the tribunal decides to end the proceedings, the fee paid to start the proceedings is not refundable.

253 Conduct of appeals

- (1) This section applies to an appeal to a tribunal.
- (2) Generally, the appellant must establish the appeal should be upheld.
- (3) However, for an appeal by the recipient of an enforcement notice, the enforcement authority that gave the notice must establish the appeal should be dismissed.
- (4) The tribunal must hear and decide the appeal by way of a reconsideration of the evidence that was before the person who made the decision appealed against.
- (5) However, the tribunal may, but need not, consider—
 - (a) other evidence presented by a party to the appeal with leave of the tribunal; or
 - (b) any information provided under section 246.

254 Deciding appeals to tribunal

- (1) This section applies to an appeal to a tribunal against a decision.
- (2) The tribunal must decide the appeal by—
 - (a) confirming the decision; or
 - (b) changing the decision; or
 - (c) replacing the decision with another decision; or
 - (d) setting the decision aside, and ordering the person who made the decision to remake the decision by a stated time; or
 - (e) for a deemed refusal of an application—
 - (i) ordering the entity responsible for deciding the application to decide the application by a stated time and, if the entity does not comply with the order, deciding the application; or
 - (ii) deciding the application.

(3) However, the tribunal must not make a change, other than a minor change, to a development application.

(4) The tribunal's decision takes the place of the decision appealed against.

(5) The tribunal's decision starts to have effect—

(a) if a party does not appeal the decision—at the end of the appeal period for the decision; or

(b) if a party appeals against the decision to the P&E Court—subject to the decision of the court, when the appeal ends.

255 Notice of tribunal's decision

A tribunal must give a decision notice about the tribunal's decision for tribunal proceedings, other than for any directions or interim orders given by the tribunal, to all parties to proceedings.

256 No costs orders

A tribunal must not make any order as to costs.

257 Recipient's notice of compliance with direction or order

If a tribunal directs or orders a party to do something, the party must notify the registrar when the thing is done.

258 Tribunal may extend period to take action

(1) This section applies if, under this chapter, an action for tribunal proceedings must be taken within a stated period or before a stated time, even if the period has ended or the time has passed.

(2) The tribunal may allow a longer period or a different time to take the action if the tribunal considers there are sufficient grounds for the extension.

259 Publication of tribunal decisions

The registrar must publish tribunal decisions under the arrangements, and in the way, that the chief executive decides.

Schedule 1 Appeals

section 229

Appeal rights and parties to appeals

(1) Table 1 states the matters that may be appealed to—

(a) the P&E court; or

(b) a tribunal.

(2) However, table 1 applies to a tribunal only if the matter involves—

(a) the refusal, or deemed refusal of a development application, for—

(i) a material change of use for a classified building; or

(ii) operational work associated with building work, a retaining wall, or a tennis court; or

(b) a provision of a development approval for—

(i) a material change of use for a classified building; or

(ii) operational work associated with building work, a retaining wall, or a tennis court; or

(c) if a development permit was applied for—the decision to give a preliminary approval for—

(i) a material change of use for a classified building; or

(ii) operational work associated with building work, a retaining wall, or a tennis court; or

(d) a development condition if—

(i) the development approval is only for a material change of use that involves the use of a building classified under the Building Code as a class 2 building; and

(ii) the building is, or is proposed to be, not more than 3 storeys; and

(iii) the proposed development is for not more than 60 sole-occupancy units; or

(e) a decision for, or a deemed refusal of, an extension application for a development approval that is only for a material change of use of a classified building; or

(f) a decision for, or a deemed refusal of, a change

application for a development approval that is only for a material change of use of a classified building; or

(g) a matter under this Act, to the extent the matter relates to the Building Act, other than a matter under that Act that may or must be decided by the Queensland Building and Construction Commission; or

(h) a decision to give an enforcement notice—

(i) in relation to a matter under paragraphs (a) to (g); or

(ii) under the Plumbing and Drainage Act; or

(i) an infrastructure charges notice; or

(j) the refusal, or deemed refusal, of a conversion application; or

(l) a matter prescribed by regulation.

(3) Also, table 1 does not apply to a tribunal if the matter involves—

(a) for a matter in subsection (2)(a) to (d)—

(i) a development approval for which the development application required impact assessment; and

(ii) a development approval in relation to which the assessment manager received a properly made submission for the development application; or

(b) a provision of a development approval about the identification or inclusion, under a variation approval, of a matter for the development.

(4) Table 2 states the matters that may be appealed only to the P&E Court.

(5) Table 3 states the matters that may be appealed only to the tribunal.

(6) In each table—

(a) column 1 states the appellant in the appeal; and

(b) column 2 states the respondent in the appeal; and

(c) column 3 states the co-respondent (if any) in the appeal; and

(d) column 4 states the co-respondents by election (if any) in the appeal.

(7) If the chief executive receives a notice of appeal under section 230(3)(f), the chief executive may elect to be a co-respondent in the appeal.

(8) In this section—

storey see the Building Code, part A1.1.

Table 1

Appeals to the P&E Court and, for certain matters, to a tribunal

1. Development applications

For a development application other than a development application called in by the Minister, an appeal may be made against—

(a) the refusal of all or part of the development application; or

(b) the deemed refusal of the development application; or

(c) a provision of the development approval; or

(d) if a development permit was applied for—the decision to give a preliminary approval.

**EXTRACT FROM THE PLANNING ACT 2016
RELATING TO LAPSE DATES**

***Division 4 Lapsing of and extending
development approvals***

85 Lapsing of approval at end of current period

*(1) A part of a development approval lapses at the end of the following period (the **currency period**)—*

(a) for any part of the development approval relating to a material change of use—if the first change of use does not happen within—

(i) the period stated for that part of the approval; or

(ii) if no period is stated—6 years after the approval starts to have effect;

(b) for any part of the development approval relating to reconfiguring a lot—if a plan for the reconfiguration that, under the Land Title Act, is required to be given to a local government for approval is not given to the local government within—

(i) the period stated for that part of the approval; or

(ii) if no period is stated—4 years after the approval starts to have effect;

(c) for any other part of the development approval if the development does not substantially start within—

(i) the period stated for that part of the approval; or

(ii) if no period is stated—2 years after the approval starts to take effect.

(2) If part of a development approval lapses, any monetary security given for that part of the approval must be released.